

NEO

Photo-ionization Detectors

User's Guide



Version 1.21

June 2019

Contents

Read Before Operating	3
General Information	4
User Interface	5
Display	6
Charging a Lithium-Ion Battery	7
Low Voltage Warning.....	7
Clock Battery.....	7
Data Protection While Power Is Off.....	7
Instrument Operation	8
Basic User Mode	8
Turning The Instrument On.....	8
Turning the Instrument Off.....	9
User Mode Summary.....	9
Integrated Sampling Pump.....	9
Pump Status.....	10
External Water-trap Filter.....	10
Alarm Signals.....	10
Alarm Signal Summary.....	10
Preset Alarm Limits & Calibration.....	11
Testing The Alarms.....	11
Backlight.....	11
Datalogging.....	11
Man Down.....	11
Wireless.....	12
Configuration Mode	12
Navigating Config Mode.....	12
Selection From a List.....	12
Entering Numerical Values.....	12
Entering and Exiting Config Mode.....	13
Config Mode Menus.....	13
Calibration.....	15
Measurement.....	17
Alarm Settings.....	18
Datalog.....	19
Monitor (Mnt) Setup.....	20
Computer Interface Using mPower Suite	24
Maintenance	26
Cleaning or Changing PID Sensor/Lamp.....	26
Lamp Cleaning and Changing.....	26
Sensor Cleaning.....	27
Sampling Pump.....	27
Troubleshooting.....	28
Contact Information	29

Read Before Operating

This manual must be carefully read by all individuals who have or will have the responsibility of using, maintaining, or servicing this product.

The product will perform as designed only if it is used, maintained, and serviced in accordance with the manufacturer's instructions.

The user should understand how to set the correct parameters and interpret the obtained results.

CAUTION!

To reduce the risk of electric shock, turn the power off before removing the instrument cover. Disconnect the battery before removing sensor module for service. Never operate the instrument when the cover is removed. Remove instrument cover and sensor module only in an area known to be non-hazardous.

Special Notes



When the instrument is taken out of the transport case and turned on for the first time, there may be some residual organic or inorganic vapor trapped inside the detector chamber. The initial PID sensor reading may indicate a few ppm. Enter an area known to be free of any organic vapor and turn on the instrument. After running for several minutes, the residual vapor in the detector chamber will be cleared and the reading should return to zero.



The battery of the instrument discharges slowly even if it is turned off. If the instrument has not been charged for 5 to 7 days, the battery voltage may be low. Therefore, it is a good practice to always charge the instrument before using it. It is also recommended to fully charge the instrument for at least 10 hours before the first use. Refer to this User Guide's section on battery charging for more information on battery charging and replacement.



Do not remove the filter when the instrument is on, otherwise, dust entry will reduce the accuracy of measurement, shorten the life of the sensor, and possibly damage the sensor.

WARNINGS

STATIC HAZARD: Clean only with a damp cloth.

For safety reasons, this equipment must be operated and serviced by qualified personnel only. Read and understand the instruction manual completely before operating or servicing.

- Use only mPower battery pack M011-3002-000. Substitution of components may impair intrinsic safety. Recharge batteries only in non-hazardous locations.
- Do not mix old and new batteries or batteries from different manufacturers.
- For maximum safety, the accuracy of the instrument should be checked by exposing it to a known concentration calibration gas before each day's use.
- Do not use USB/PC communication in a hazardous location.

General Information

The NEO is one of the most advanced handheld VOC (Volatile Organic Compound) monitors available for ppb (parts per billion) detection. The NEO offers several models from the most sensitive 1 ppb to a high range up to 15000 ppm for different applications and user selections. Novel designs of the photo-ionization detector (PID) and ultraviolet (UV) lamp provide outstanding sensitivity, stability and reproducibility. Options include real time data monitoring with a built-in wireless modem using mPower Suite application software.

Key Features

- Size: 9.1 x 2.9 x 2.2 in (230 x 74 x 55 mm)
- Weight: 24.95 oz (708 g)
- 1 ppb to 15000 ppm ranges of VOC
- 3-second response time for 90% change (using isobutylene)
- Large and intuitive display
- Integrated correction factors list of more than 200 compounds
- Built-in pump for up to 30 meters sampling distance
- Man-down alarm with real-time remote wireless notification
- ISM wireless connection option
- Easy service and maintenance
- Micro-USB charge port

User Interface

The instrument's user interface consists of the LCD display, Alarm LEDs, an alarm transducer, and four keys. The keys are:

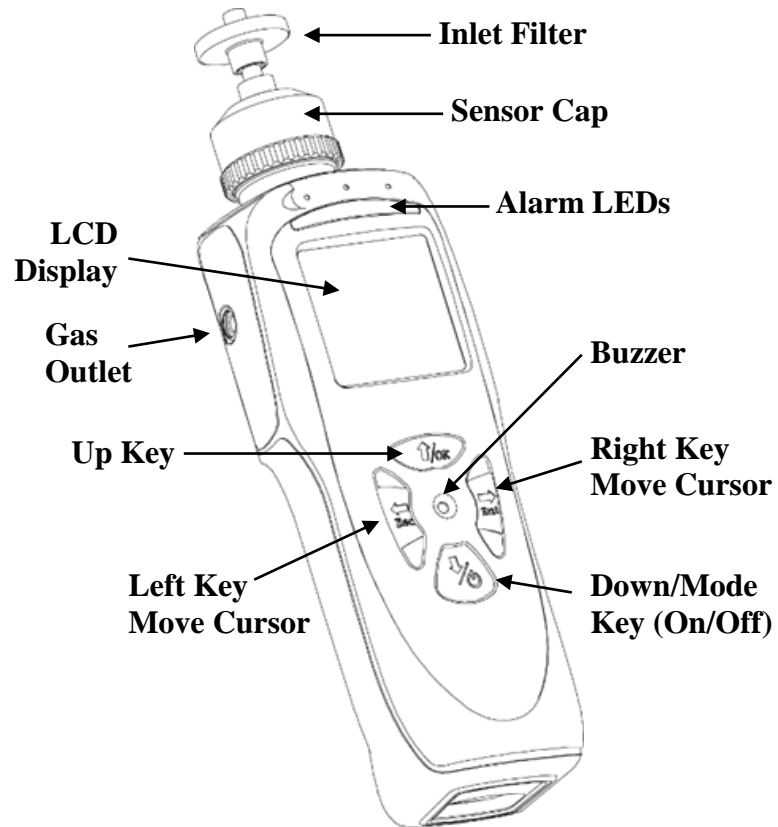
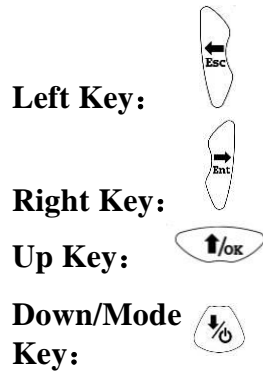

NEO user interface

Display

The LCD display provides visual feedback that includes the reading, pump, Man Down, time, battery condition, and other functions.

The display shows the following information:

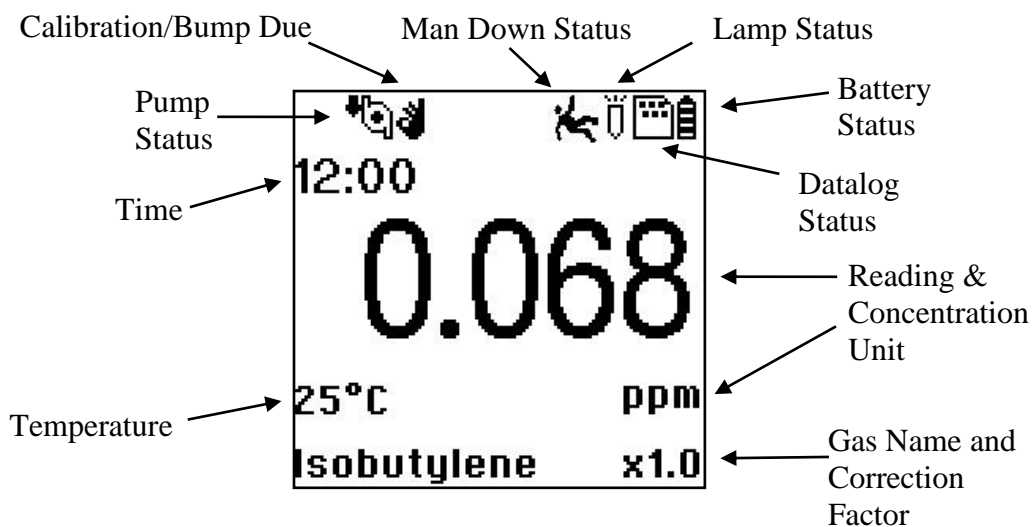

LCD display

Item	Description
Gas information	Shows the measurement gas and its correction factor
Reading	Concentration of gas measured by the instrument
Calibration/Bump Due	Indicates if calibration or bump status is OK or not
Pump Status	Indicates whether the pump is working or blocked
Man Down Status	Indicates if Man Down alarm is on
Lamp Status	Indicates if the lamp is on or not
Datalog Status	Indicates whether datalog is on or off
Battery Status	Indicates battery capacity in 3 bars
Time	Indicates current time
Temperature	Indicates current temperature

Charging a Lithium-Ion Battery

Always fully charge the battery before using the instrument. The screen will display a battery icon from empty (no bars) to fully charged (3 bars).

Follow this procedure to charge the instrument:

1. Plug the Micro-USB into the charging port at the bottom of the instrument.
2. Plug the USB connector* into either a) a personal computer, or b) into the AC/DC adapter and plug the AC/DC adapter into the wall outlet.

The instrument begins charging automatically. The charging LED turns red to indicate charging. During charging, the 3 bars in the battery icon on the instrument's display are animated. When the battery is fully charged, the LED turns green, the icon is no longer animated and shows a full battery, and the message 'Fully Charged' is displayed.



***NOTE:** Any locally-obtained USB A to Micro B USB cable will work for charging, but will not work for communication with mPower Suite configuration and data transfer software. The mPower USB cable P/N M-011-3003-000 is required for a PC to recognize the instrument and communicate with mPower Suite.

WARNING!

To reduce the risk of ignition of hazardous atmospheres, recharge and replace batteries only in areas known to be non-hazardous. Use only mPower's rechargeable lithium battery part number: M011-3002-000.

Low Voltage Warning

When the battery's charge falls below a preset voltage, the instrument warns you by beeping once and flashing once every minute, and the "empty battery" icon blinks on and off once per second. Turn off the instrument within 10 minutes and either recharge the battery, or replace the battery with a fresh one with a full charge.



Clock Battery

An internal clock battery is mounted on one of the instrument's printed circuit boards. This long-life battery keeps settings in memory from being lost whenever the Li-ion battery or alkaline batteries are removed. This backup battery should last approximately five years, and must be replaced by an authorized mPower service technician. It is not user-replaceable.

Data Protection While Power Is Off

When the instrument is turned off, all the current real-time data including last measured values are erased. However, the logged data are preserved in non-volatile memory, so that even if the battery is disconnected, the logged data will not be lost.

Instrument Operation

The NEO gives real-time measurements and activates alarm signals whenever the readings exceeds preset limits. Prior to factory shipment, the instrument is preset with default alarm limits and the sensor is pre-calibrated with standard calibration gas. However, the instrument should be tested and the calibration verified before the first use. After the instrument is fully charged and calibrated, it is ready for immediate operation.

The instrument works in different operation modes defined by the product model and factory setting. When the unit is turned on, it enters **User Mode**, where basic users can only see and use a limited set of functions. In **Configuration Mode**, which is password protected, advanced users can adjust various settings. In some cases, Configuration Mode is not accessible on the instrument display and the mPower Suite software must be used to change settings.

Basic User Mode

Turning The Instrument On

Press and hold the Mode key  until the display, beep buzzer & LEDs turn on, and then release.

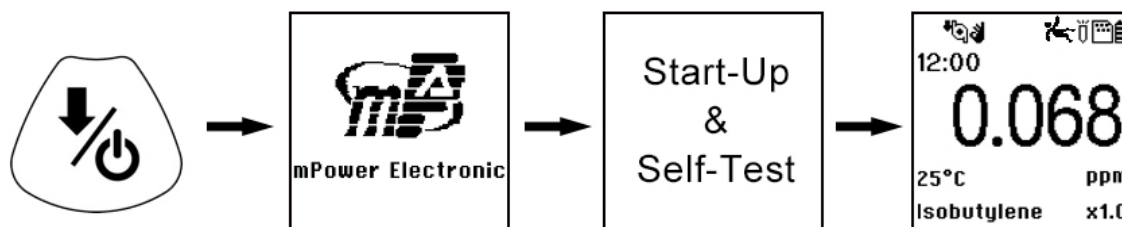

If the mPower logo does not appear first, there is likely a problem and a distributor or mPower Technical Support should be contacted. The instrument then performs self-tests after the screen displays the firmware version and serial number.

Self-tests include:

Self Test	
Pump.....	OK
Clock.....	OK
Datalog.....	OK
Motion.....	OK
PID.....	OK

After self-tests, the instrument will show sensor information and instrument configuration information in sequence.

Once the startup procedure is complete, and a numerical reading screen with icons is displayed, the instrument is fully functional and ready for use.

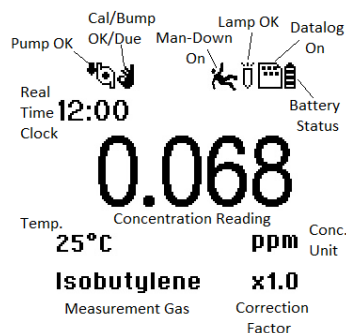



Turning the Instrument Off

Press and hold the Mode key  for 3 seconds, and continue to hold for a 5-second countdown until “Unit off...” is displayed.

User Mode Summary

The instrument will be running in basic User Mode after being turned on. It will show the real-time reading and auxiliary information.

Press the Up key  or Mode key  to cycle through the main menu screens. If no action is taken on any screen for 60 seconds, the display will return to the main menu automatically.

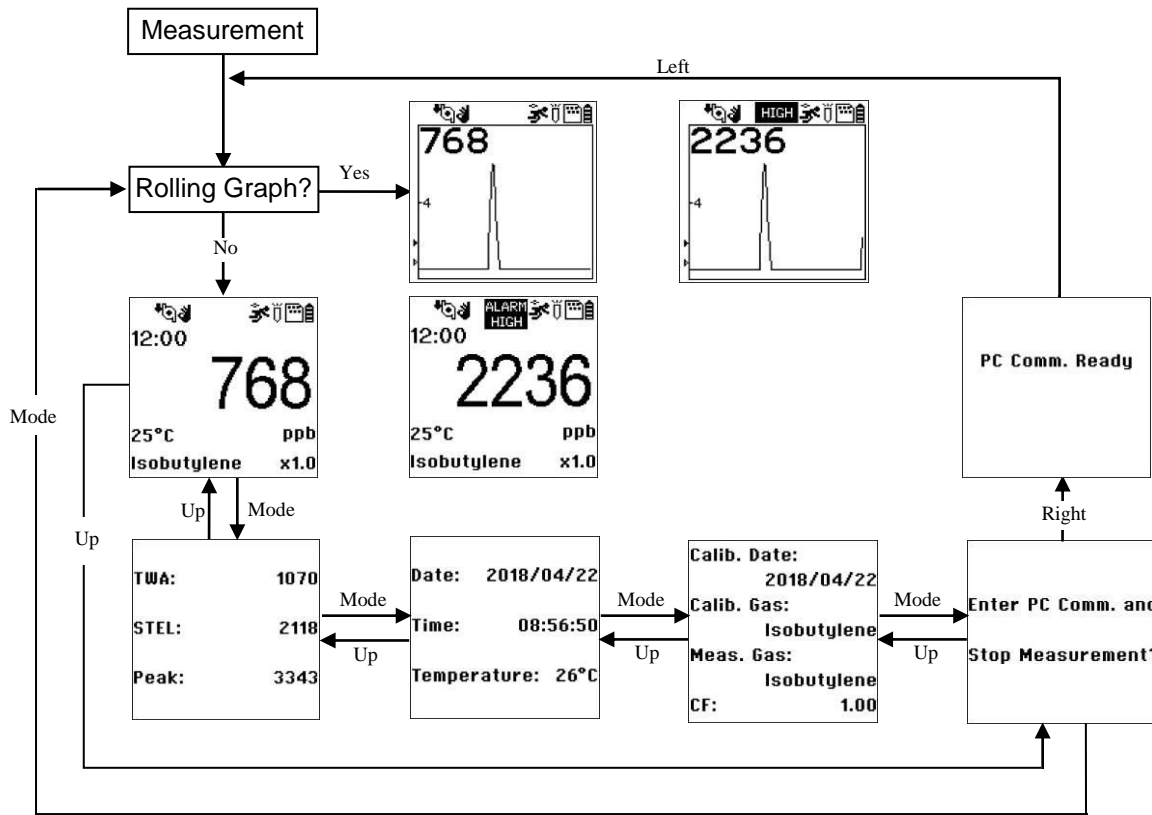

Flow chart for basic User Mode

Integrated Sampling Pump

The instrument includes an integrated, diaphragm-type sampling pump, providing flow rates of 330 to 450 cc/min. adjustable in three speed settings. When used with a 25 mm diameter 0.45 µm filters the flow rate is about 250 to 360 cc/min. at low and high settings. Flow will decrease if the filter accumulates particulate matter, or if a filter is not used and particles get caught in the pump diaphragm. Connecting Teflon tubing with 1/8" inside diameter to the gas inlet port, this pump can pull air samples from 200' (61 m) away horizontally, or 90' (27.5 m) vertically, at about 3' (0.9 m) per second flow rate. Note that at 200' the PID response will be delayed by about 1 minute, the time required for the gas sample to reach the instrument.

IMPORTANT!

During operation, make sure the probe inlet and the gas outlet are free of obstructions. Obstructions can cause premature wear on the pump, false readings, or pump stalling.

Pump Status

During normal operation, the pump icon alternately shows inflow and outflow. If there is a pump failure or obstruction, the alarm sounds and the pump stall icon blinks on and off. If this occurs, clear the obstruction and press the Right key to restart the pump.



External Water-trap Filter

The external filter is made of a PTFE (Teflon®) or PVDF membrane with 0.45 micron pore size to prevent dust or other particles from being sucked into the sensor manifold, which could damage the instrument. It prolongs the operating life of the sensor and pump. To install the external filter, simply screw it in to the instrument's inlet probe using the Luer connection.

Alarm Signals

During each measurement period, the gas concentration is compared with the programmed alarm limits (gas concentration alarm limit settings). If the concentration exceeds any of the preset limits, the loud buzzer and red flashing LED are activated immediately to warn of the alarm condition.

In addition, the instrument alarms if one of the following conditions occurs: battery voltage falls below a preset voltage level, failure of the UV lamp, or pump stall.

Alarm Signal Summary

Message	Condition	Alarm Signal
HIGH	Gas exceeds 'High Alarm' limit	3 beeps/flashes per second
OVR	Gas exceeds measurement range	3 beeps/flashes per second
MAX	Gas exceeds electronics' maximum range	3 beeps/flashes per second
LOW	Gas exceeds 'Low Alarm' limit	2 beeps/flashes per second
TWA	Gas exceeds 'TWA' limit	1 Beep/flash per second
STEL	Gas exceeds 'STEL' limit	1 Beep/flash per second
Pump icon flashes	Pump failure	3 beeps/flashes per second
Lamp	PID lamp failure	3 beeps/flashes per second plus 'Lamp' message
Battery icon flashes	Low battery	1 flash, 1 beep per minute plus battery icon flashes
CAL	Calibration failed, or is overdue	1 beep/flash per second
NEG	Gas reading measures less than number stored in calibration	1 beep/flash per second

Preset Alarm Limits & Calibration

The instrument is factory calibrated with standard calibration gas, and is programmed with default alarm limits. For example, on the NEO PPM, the default values are:

Cal Gas	Cal Span	unit	Low	High	TWA	STEL
Isobutylene	10	ppm	50	100	10	25

Alarm limits and calibration parameters can be adjusted in Configuration Mode as desired for particular testing purposes and applications.

Testing The Alarms

The alarm can be tested whenever the main (Reading) display is shown. Press the Right key, and the audible and visible alarms are tested.

Backlight

The LCD display is equipped with an LED backlight to assist in reading the display under poor lighting conditions. Background lights can be turned on automatically under poor light condition and be set in a variety of ways. We can choose from the settings menu under Config Mode or through mPower Suite.

Datalogging

During datalogging, the instrument displays a disk icon to indicate that datalogging is enabled. The default status is to have datalogging on, at 60-second intervals, which allows up to one year of data storage.

The instrument stores the measured gas concentration at the end of every sample interval (when datalogging is enabled). In addition, the following information is stored: user ID, site ID, serial number, last calibration date, and alarm limits. All data are retained (even after the unit is turned off) in non-volatile memory so that it can be down-loaded at a later time to a PC. Stored data are organized into 'events', with a new event created each time the instrument is turned on, or a configuration parameter is changed, or datalogging is interrupted.

After an event is recorded, the unit records a shorter form of the data. When transferred to a PC running mPower Suite, these data are arranged with a sample number, time, date, gas concentration.

Man Down

Settings are available for On/Off depending on the user's requirement.

The Man Down Alarm is a critical and potentially lifesaving safety feature of the NEO. Its function is based on the premise that if the instrument is motionless when it is not supposed to be, something wrong may be happening to its user. If that is the case, the NEO not only goes into alarm locally on the instrument, but also remotely, over a wireless network, to notify people in the vicinity, as well as remote safety officers at a command center, that a person is down, so that help can be dispatched quickly.

Note: Remote notification requires wireless connection to a network.

Wireless

When NEO is equipped with wireless capability, it is set up through the wireless sub-menu.

Configuration Mode

The Config Mode is used to modify the instrument configuration settings.





Navigating Config Mode

There are two types of menus in Config mode: 1) those that ask for selection from a list and 2) those that ask for a numerical value to be entered.

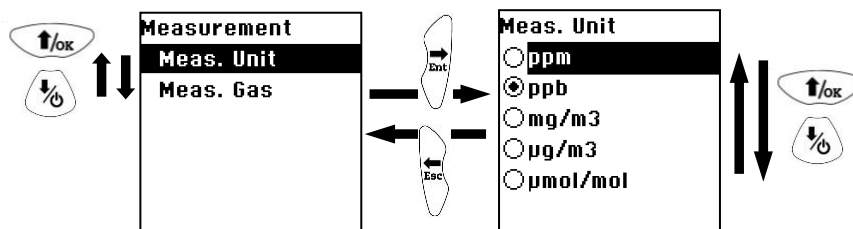
Selection From a List







For example, the Measurement sub-menu contains both a text-format list and a radial-button list.



- Press the Up key  or Mode key  to scroll through the list.
- Press the Right key  to select the menu item.
- Press the Left key  to save and exit.



Entering Numerical Values

For example, to enter a numerical password:

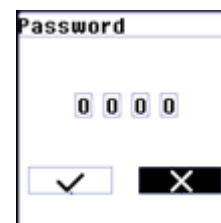
- Increase or decrease the number from 0 through 9 by pressing the Up key  or Mode key .
- Press the Left key  or Right key  to move the cursor.
- After entering the desired numbers, press the Left key  or Right key  to move the cursor to the '✓' mark, and then press the Up key  to accept and move to the next menu.



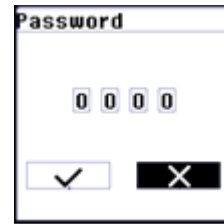

Entering and Exiting Config Mode

From the main reading display, press and hold the Up key  and Mode key  simultaneously until the Password screen is shown. Input the 4-digit password, move the cursor to '✓', then press the Up key  to enter Configuration Mode.



Note: The default password is 0000. The password can only be changed by connecting the instrument to a PC running mPower Suite software.







Upon successfully entering Config Mode, the screen on the right will be displayed. The Calibration label is shown and its icon is highlighted. Use the Up key  or Mode key  to scroll through the menu until the desired item is reached, and use the Right key to select it.



To **Exit Config Mode** and return to normal operation, press the Left key repeatedly from any of the Config Menu displays.

Config Mode Menus

This table summarizes the Config Mode menus and sub-menus. Not all of these menus will be displayed if the option is not set up using mPower Suite software

					
Calibration	Measurement	Alarm Setting	Datalog	Monitor Setup	Wireless
Zero Calib	Meas. Unit	Alarm Limits	Clear Datalog	Data & Time	Radio On/Off
Span Calib	Meas. Gas	Alarm Mode	Interval	Display	
Set Cal.Gas		Alarm Settings		Pump Speed	
Set Span Value		Comfort Beep		Set Pump Stall	
Set Span 2 Value		Man-Down Alarm		3-Point Cal.	
				Rolling Graph	
				Real Time Data	
				Language	
				Self-Zeroing	

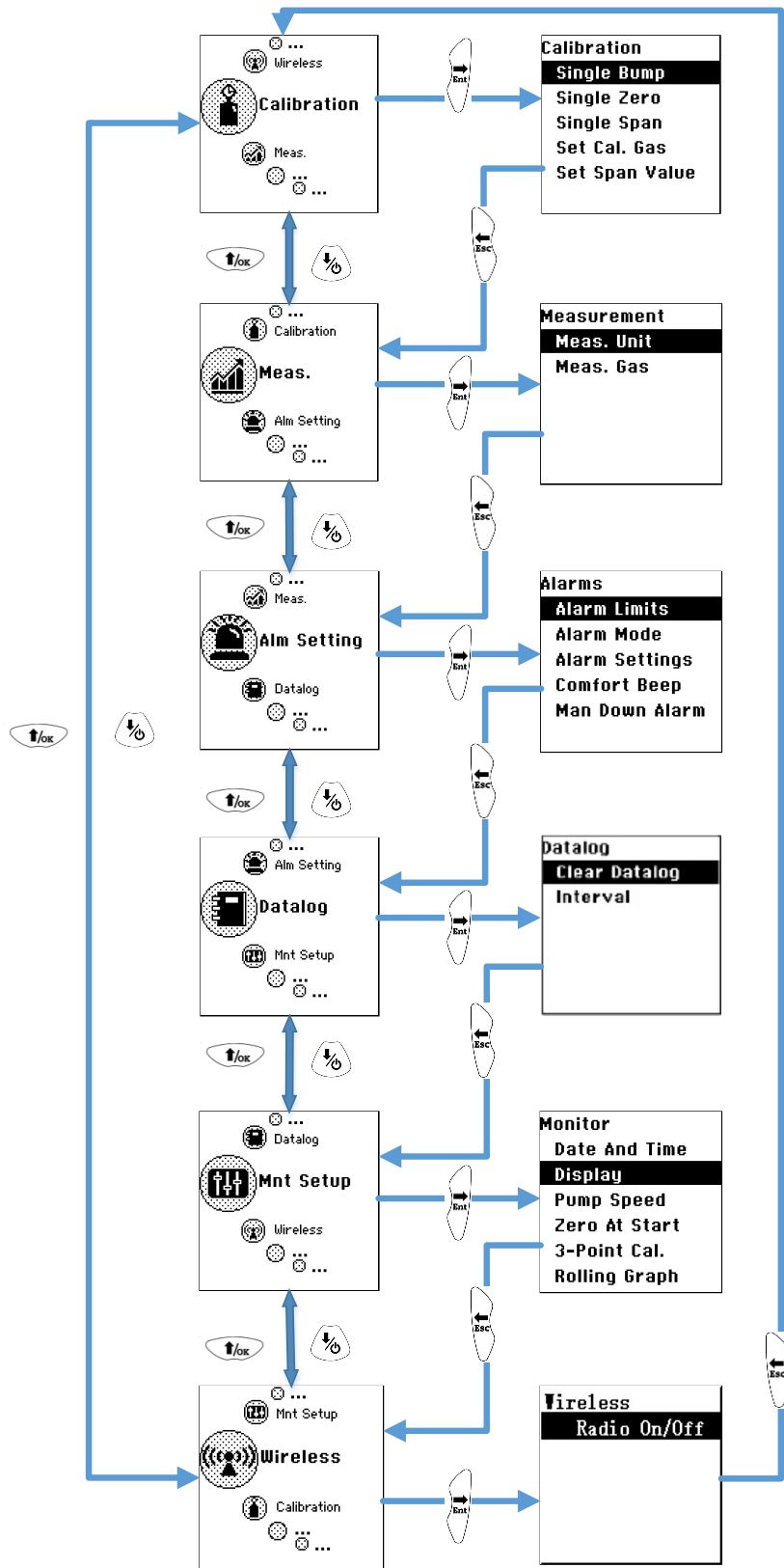

Fig 4: Flow chart for Configuration Mode

Calibration

Calibration Overview

Although the instrument will typically hold an approximate calibration for several weeks, when used for worker health and safety it should be calibrated or bump tested before each day's use. The interval between span calibrations can be extended based on the user's experience for how long the calibration holds under their operating conditions. For best accuracy the calibration gas chosen is the same as the gas to be measured. However, this is often inconvenient, and isobutylene has become the standard surrogate calibration gas because it has good response and is inexpensive, stable, and non-toxic. A correction factor (CF) can then be applied to make the NEO display in true concentration units of the gas being measured. This CF is selected from the instrument's gas library of over 200 compounds, or entered manually.



Calibration Set-Up

Span gas from a cylinder is conveniently supplied to the instrument using a regulator with fixed flow rate of about 0.5L/min (500 cc per min.) to match or slightly exceed the flow rate of the instrument pump. Alternatively, the span gas can first be filled into a gas bag (e.g., Tedlar® bag) or delivered through a demand-flow regulator to match the pump flow precisely. Another alternative is to use a regulator with >500 cc/min flow but allow the excess flow to escape through a T connector or an open tube.

Zero Calibration

This procedure determines the zero point of the sensor calibration curve. Connect the instrument to a clean air source free of VOCs such as from a cylinder, gas bag, or ambient air filtered through a charcoal tube (VOC Zeroing Tube). Most outdoor air is sufficiently free of contaminants that it can be used for zero calibration except for measurements in the low ppb range. The air source should have an oxygen concentration of 20.9% (or the same as in the gas to be measured) because oxygen levels have some effect on the PID response.

Select 'Zero Calib' by pressing the Right key to enter the submenu. The message 'Please Apply Zero Gas' is displayed. Start the zero calibration by pressing the Up key, and a 30-second countdown begins.



Note: To abort the zeroing and proceed to Span calibration, press the Left key at any time during the process. A confirmation message 'Zero aborted!' will appear, followed by the Span calibration menu.

When complete, this message "Zero Calibration Done!" is shown, and the display automatically moves to the Span Calibration menu.

Span Calibration

This procedure determines the second (and third, if 3-Point Cal is selected in Monitor Setup) point(s) of the sensor calibration curve. One or two cylinders of standard reference gas (span gas) fitted with a 500 cc/min flow-limiting regulator or a flow-matching regulator is the simplest way to perform this procedure. The span gas concentration should be chosen to be near the highest concentration of actual measurements expected. It is also preferred to use the same balance gas (e.g., air or nitrogen) as occurs in the actual measurements.

To perform a Span calibration, connect the calibration adapter to the inlet port of the instrument, and connect the tubing to the regulator or gas bag. Select 'Span Calib' by pressing the Right key to enter the submenu. The message 'Please Apply Gas' is displayed. Start the span calibration by pressing the Up key, which begins a 30- second countdown.

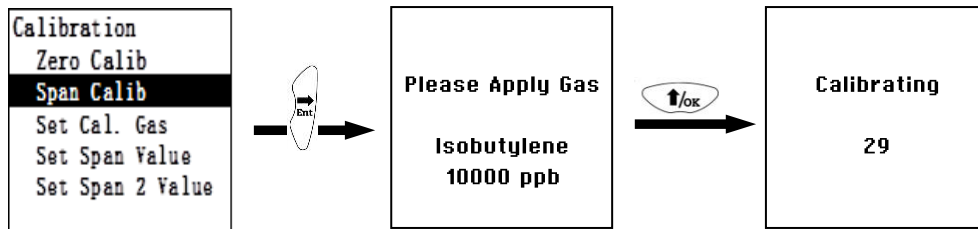

Note: To abort the Span calibration, press the Left key at any time during the process. The confirmation message 'Span is aborted!' appears followed by the next menu item.

When Span 1 calibration is complete, a message similar to this is displayed (the value is an example only):

Span 1 is done!
Reading = 10.0 ppm

3-Point Calibration

If '3-Point Cal.' is enabled (see Monitor Setup), proceed to perform Span 2 in the same manner as for Span 1.

3-Point calibration should be used whenever enhanced accuracy is required. It is especially recommended for measurements above about 500 ppm, where PID response is not quite as linear.

Set Calibration Gas

In the Set Cal. Gas menu, select the calibration gas from either the mPower Gas Library or the user's Custom Gases list. Custom Gas names and parameters can only be set up through the mPower Suite software.

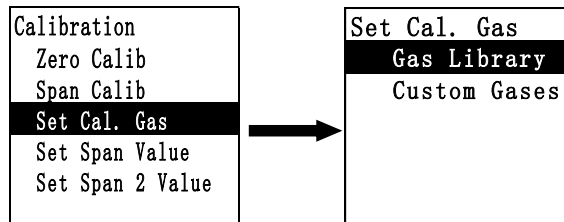

Press the Right key to select Gas Library, or Custom Gases. Press the Up key or Mode key to scroll through the gas list. For high-speed scrolling, press and hold the Up key until the desired gas name is reached. Press the Right key to select the gas and the Left key to save and exit.

Set Span Value

Span value settings (including Span 2) should match the concentration(s) of standard gas. Check to ensure that the unit of concentration (e.g., ppm or mg/m³) on the gas cylinder agrees with the instrument setting.

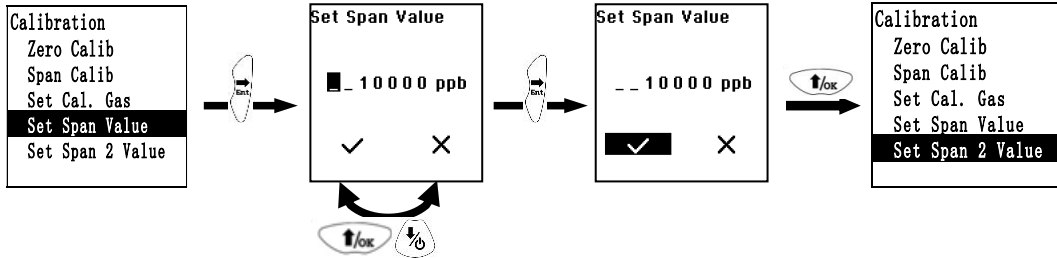

Measurement

The sub-menus for Measurement are Measurement Unit and Measurement Gas.

Measurement Unit

Standard available measurement units include:

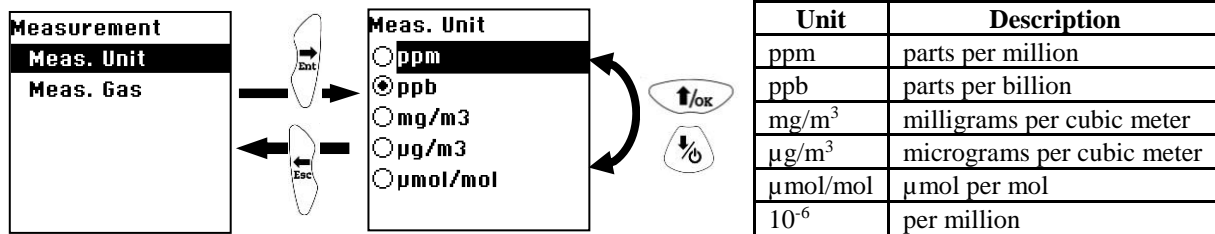

Measurement Gas

Measurement gases are organized in two lists:

- Gas Library is a pre-set list that contains a few hundred chemicals detectable by PID.
- Custom Gases are user-defined, using mPower Suite to set up all gas parameters, including the name, span value(s), correction factor(s), and default alarm limits.

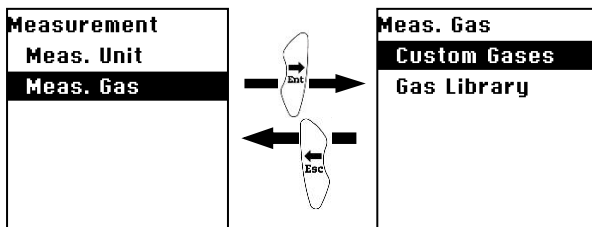
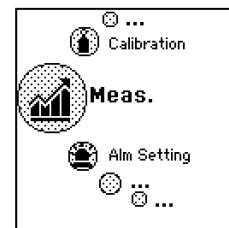

Press the Right key to select Gas Library, or Custom Gases. Press the Up key or Mode key to scroll through the gas list. For high-speed scrolling, press and hold the Up key until the desired gas name is reached. Press the Right key to select the gas and the Left key to save and exit.

Alarm Settings

During each measurement period, the gas concentration is compared with the programmed alarm limits (Low, High, TWA and STEL). If the concentration exceeds any of the preset limits, the loud buzzer and red flashing LED are activated immediately to warn of the alarm condition. Press the Right key to enter the Alarm Setting menu.

Alarm Limits

In this menu, the High, Low, STEL, and the TWA alarm limits can be changed. Press the Right key to enter the Alarm Limits menu.

High Alarm

The default High Alarm limit is set by the instrument to match the value for the current measurement gas. To change the High Alarm limit press the Up or Mode key to increase or decrease each digit's value, and the Right or Left key to move the cursor. Move the cursor to '✓' after the setting is complete, and press Up to save and exit.

Low, STEL and TWA Alarms

Set the Low, STEL and TWA Alarm limits in the same manner as described above for the High Alarm limit.

Note: All default alarm limits depend on the measurement gas and are expressed in ppm.

Alarm Mode

There are two selectable alarm modes:

Latched

When the alarm is triggered, it stays on even when the concentration falls back below the alarm limit. The alarm must be stopped manually by pressing the Right key. The latched setting only controls High, Low, STEL, and TWA alarms.

Automatic Reset

When the alarm condition is no longer present, the alarm stops automatically.

Press the Up or Mode key to step from one alarm mode to the other. Press Right to select an alarm mode followed by Left to save and exit.

Alarm Settings

The buzzer and light alarms can be programmed to be on or off individually or in combination. The choices are:

- Both on
- Light only
- Buzzer only
- Both off

Press the Up or Mode key to step from one option to the next. Then press Right to make a selection followed by Left to save and exit.

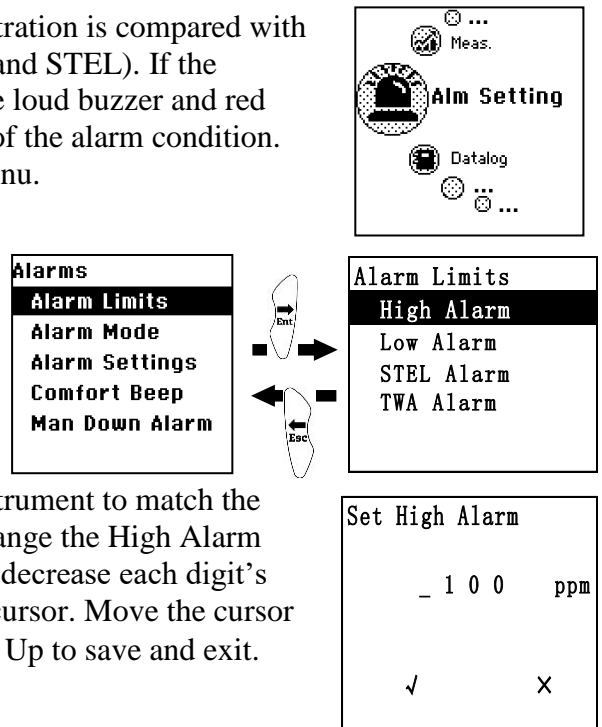

Comfort Beep

With the Comfort Beep enabled, the buzzer beeps once each minute to indicate that all is OK and the instrument is running normally.

Press the Up or Mode key to step from one option to the next. Then press Right to make a selection followed by Left to save and exit.

Man-Down Alarm

The Man-Down alarm notifies nearby personnel if the instrument remains motionless for some time when it should be moving, indicating a possible worker in distress. In addition, if the wireless option is enabled, alarm notification is sent to a remote location. Press the Right key to enter Man down alarm menu.

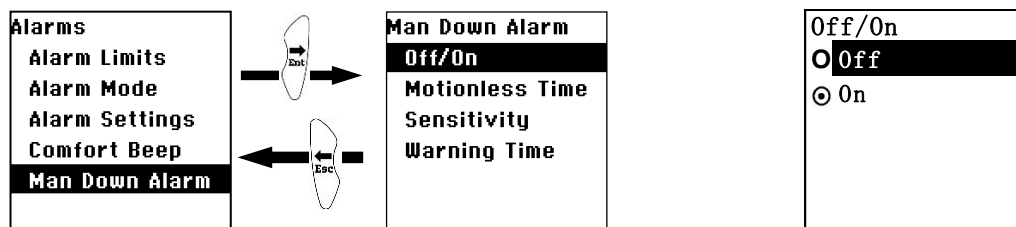

Man-Down Alarm Off/On

Press Right to make a selection followed by Left to save and exit.

Motionless Time

Motionless Time is the trigger time for Man-Down alarm when the person is motionless. The default motionless time is 30s. To change the time press the Up or Mode key to increase or decrease each digit's value, and the Right or Left key to move the cursor. Move the cursor to '✓' after the setting is complete, and press Up to save and exit.

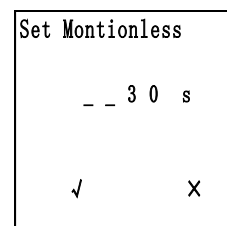

Sensitivity

This sensitivity of motion sensor can be set to Low, Medium or High. High sensitivity means that small movements are enough to prevent a Man-Down alarm. Use Up or Mode to move up or down the list, Right to select, and Left to save and exit.

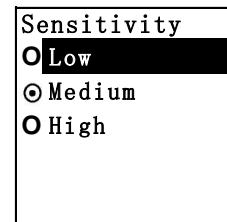

Warning Time

The Warning Time is the amount of time the Man-Down alarm stays on after it is triggered. The default time is 30s. Adjust as for Motionless Time.

Datalog

The instrument automatically stores the concentration readings at regular time intervals (this function cannot be turned off). In the datalog sub-menu, a user can adjust the interval or clear all data. Press Right to enter the Datalog menu.

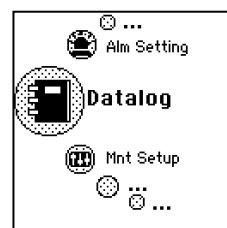

Clear Datalog

This erases all the data stored in the datalog.

Caution: Once the data are cleared, they cannot be recovered.

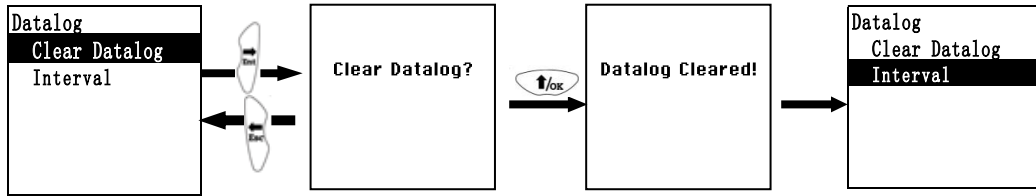

1. Press the Right key to clear the datalog. The display asks, ‘Clear Datalog?’
2. Press the Left key if you do not want to clear the datalog.
3. Press the Up key if you want to clear the datalog. When it has been cleared, the display shows ‘Datalog Cleared!’ and moves to the next sub-menu, Interval.

Interval

Intervals are shown in seconds. The default value is 60 seconds and the maximum is 3600 seconds (1 hour). There is enough data capacity to run for 6 days at 1-second intervals, 12 months at 60-second intervals, or 6 years at 10-minute intervals. Once the datalog is full, it cycles and begins to replace the oldest data.

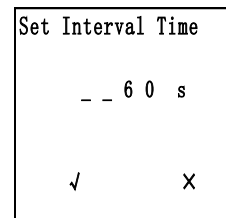

To change the Datalog Interval, press the Up or Mode key to increase or decrease each digit’s value, and the Right or Left key to move the cursor. Then move the cursor to ‘√’ and press Up to save and exit.

Monitor (Mnt) Setup

Several settings can be accessed here, including date and time, pump parameters, display parameters and selecting 3-point calibration.

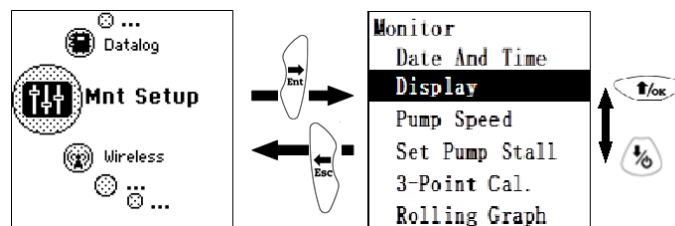

Date and Time

Date

The date is expressed as Month/Day/Year, with two digits for each. To change the date press the Up or Mode key to increase or decrease each digit’s value, and the Right or Left key to move the cursor. Move the cursor to ‘√’ after the setting is complete, and press Up to save and exit.

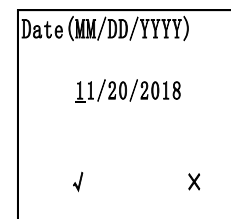

Time

The Time is expressed as Hours/Minutes/Seconds, with two digits for each. The time is in 24-hour (military) format. Adjust the time in the same manner as for the date.

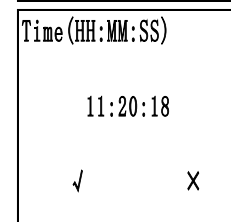

Display

The Display function is used to set LCD contrast and backlight.

LCD Contrast

The default LCD Contrast is about 50%.

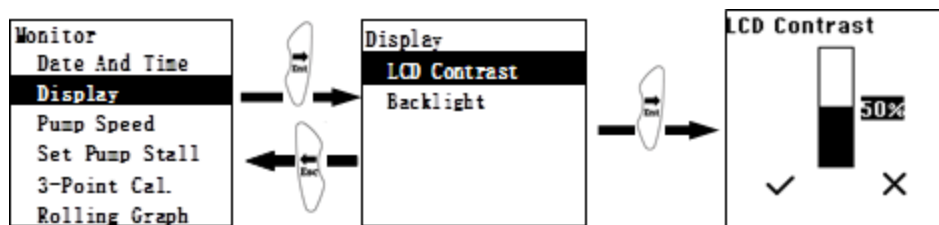

To change the contrast, press the Up or Mode key to increase or decrease the digit's value, then move the cursor to '✓' and press Up to save and exit.

Backlight

The Backlight can be set as Automatic, Manual or Off. In Automatic Mode the backlight comes on and stays on in low light conditions. In Manual Mode, pressing the Right or Left key turns the backlight on for one minute.

Pump Speed

The pump can operate at three speeds, low, medium and high, ranging from about 250 to 350 cc/min with a standard 0.45 μ m filter in place, or about 350 to 450 cc/min with the filter removed. Running at low speed is quieter and conserves a small amount of power. There is almost no difference in sampling accuracy. High pump speed is recommended for faster response when using an extension hose to sample, or when measuring heavy compounds, which tend to have slow response because of adsorption on inlet surfaces.

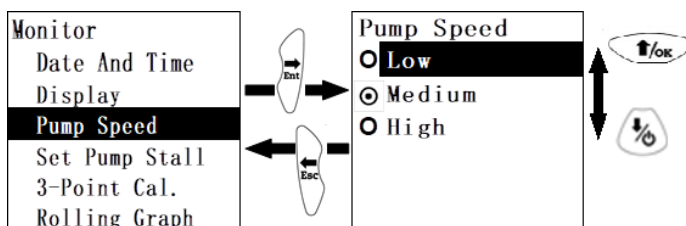

Use the Right key to enter Pump Speed, then Up or Mode to scroll on the list, Right to select, and Left to save and exit. Note that each Pump Speed has its own Stall Threshold.

Set Pump Stall Threshold

The Pump Stall Threshold is the current-draw setting for a blocked pump alarm. The default setting is 500. The actual, real-time pump current draw is displayed in the upper right corner. Briefly block the inlet probe with a finger and to observe the rise in pump current value. Set the stall threshold about 50-100 units above the unblocked pump reading, but lower than the blocked pump reading. Press the Up or Mode key to increase or decrease each digit's value, and the Right or Left key to move the cursor. Then move the cursor to '✓' and press Up to save and exit. Set a different pump stall threshold for each pump speed.

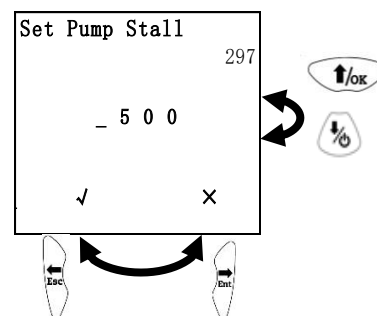

3-Point Calibration

Normally a 2-point calibration gives adequate linearity in PID response, but a 3-point calibration (Zero, Span 1 and Span 2) can be enabled for more accuracy, particularly in the high concentration range above about 500 ppm where response is less linear. Use the Right key to enter 3-Point Cal, then Up or Mode to scroll to On or Off, Right to select, and Left to save and exit.

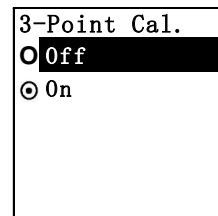

Below is the list of default 1st and 2nd Span points when using isobutylene for calibration. These settings can be changed in the Calibration menu.

NEO Model	Span	Span 2
MP181	100 ppm	1000 ppm
MP182	100 ppm	5000 ppm
MP184	10 ppm	1000 ppm
MP185	10 ppm	1000 ppm
MP186	5 ppm (benzene)	N/A

Rolling Graph

If the Rolling Graph function is enabled, the display in basic User Mode shows the instantaneous reading together with a real-time plot of immediate past readings in a 2-minute window. Enable the rolling graph as with any other list selection menu.

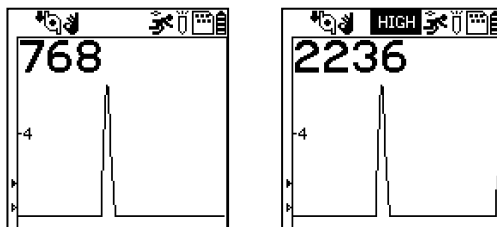

Real Time Data

Real time data output is available on some NEO models via a USB cable and/or wirelessly via Bluetooth Low Energy using an Android App. Please contact mPower for more information.

Language

The display language can be selected as English or Chinese. Chose the language as for any other list selection menu.

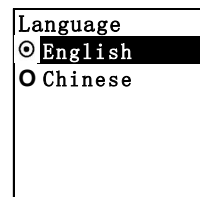

Self-Zeroing

With Self-Zeroing enabled, the instrument re-zeroes automatically if the signal drifts below the last Zero Calibration for some time. Such drift can occur 1) slowly as the lamp ages, 2) a dust or oil film accumulates on the lamp window, or 3) a change in environmental conditions such as background matrix gas, humidity or temperature. The default setting of self-zeroing is off. At the time of enabling self-zeroing, make sure the instrument is running in clear environment for several minutes to ensure that the baseline zero signal is well established. Enable this function as with any other list selection menu.

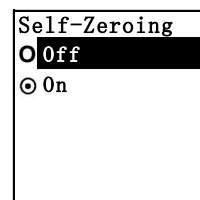

Wireless

Wireless radio communication can be enabled if the instrument has a wireless module installed. Enable this function as with any other list selection menu.

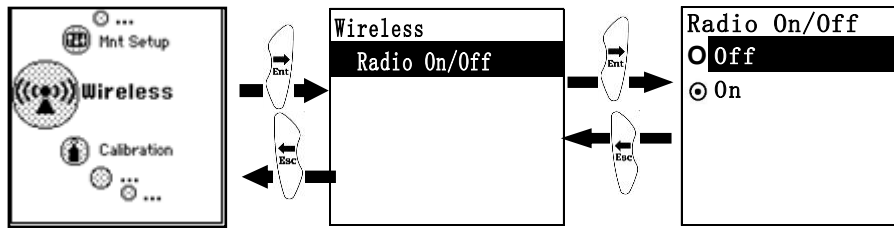

Computer Interface Using mPower Suite

The mPower Suite software can be used to 1) download logged data, 2) upload configuration parameters to the instrument, and 3) upgrade the instrument firmware. mPower Suite can be downloaded from our website at <https://www.mpowerinc.com/software-downloads/>.

Connecting and Configuring

1. Turn on the instrument and press Up from basic User Mode to go into PC comm.
2. Connect the USB cable to the PC and with the Micro-USB end to the instrument.*
3. Start mPower Suite on your PC and click the “Search” button to find the instrument.
4. Find the instrument in the left bar Device Connected list. Click on the S/N to get the configuration file from the instrument.
5. Edit the configuration parameters as desired and click “Write” to upload the configuration to the instrument.
6. “Read” allows downloading the current configuration file from the instrument.
7. “Save” allows storing the current configuration file to the PC.
8. “Load” allows calling up a stored configuration file from the PC to mPower Suite.
9. To update the instrument firmware, select “Firmware Upgrade”. The firmware must first be downloaded to the PC from the mPower website www.mPowerinc.com.

***NOTE:** Any locally-obtained USB A to Micro B USB cable will work for battery charging, but will not work for communication with mPower Suite software. The mPower USB cable P/N M-011-3003-000 is required for a PC to recognize the instrument and communicate with mPower Suite.

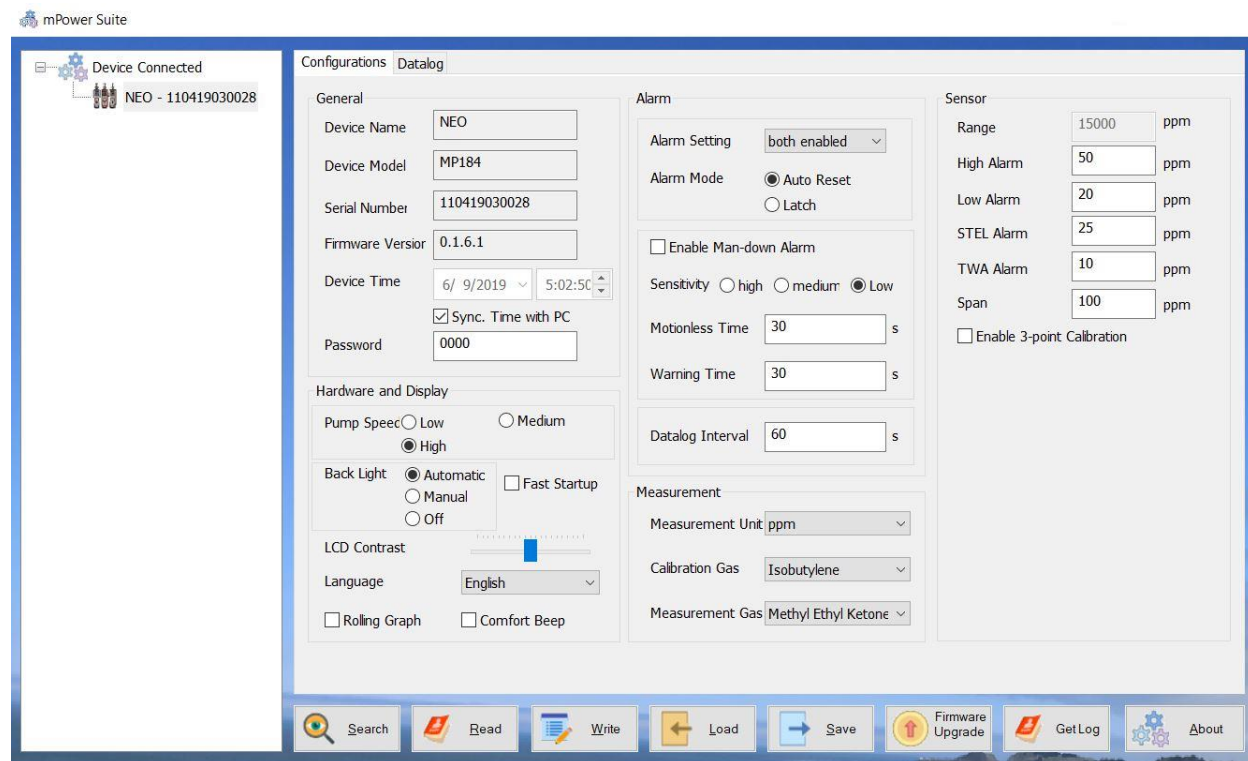

mPower Suite Configuration Screen

Datalog Retrieval

- To download the datalog from the instrument to the PC, select “Get Log”. This process can take several minutes because datalogging is always on and large files can be created. The datalog files will appear under the “Datalog” tab on the top of the screen. Below is a sample screen of datalog information listing sample point time and instantaneous reading. A new Single Datalog file is created each time the instrument is turned on or the configuration is changed. The middle panel shows the file start time and number of data points.
- To export data to a csv file readable by Excel or other spreadsheet software, move the cursor over the right data panel and click the right mouse button, and then select either the current Single Datalog file or all the stored data (Whole Datalog).

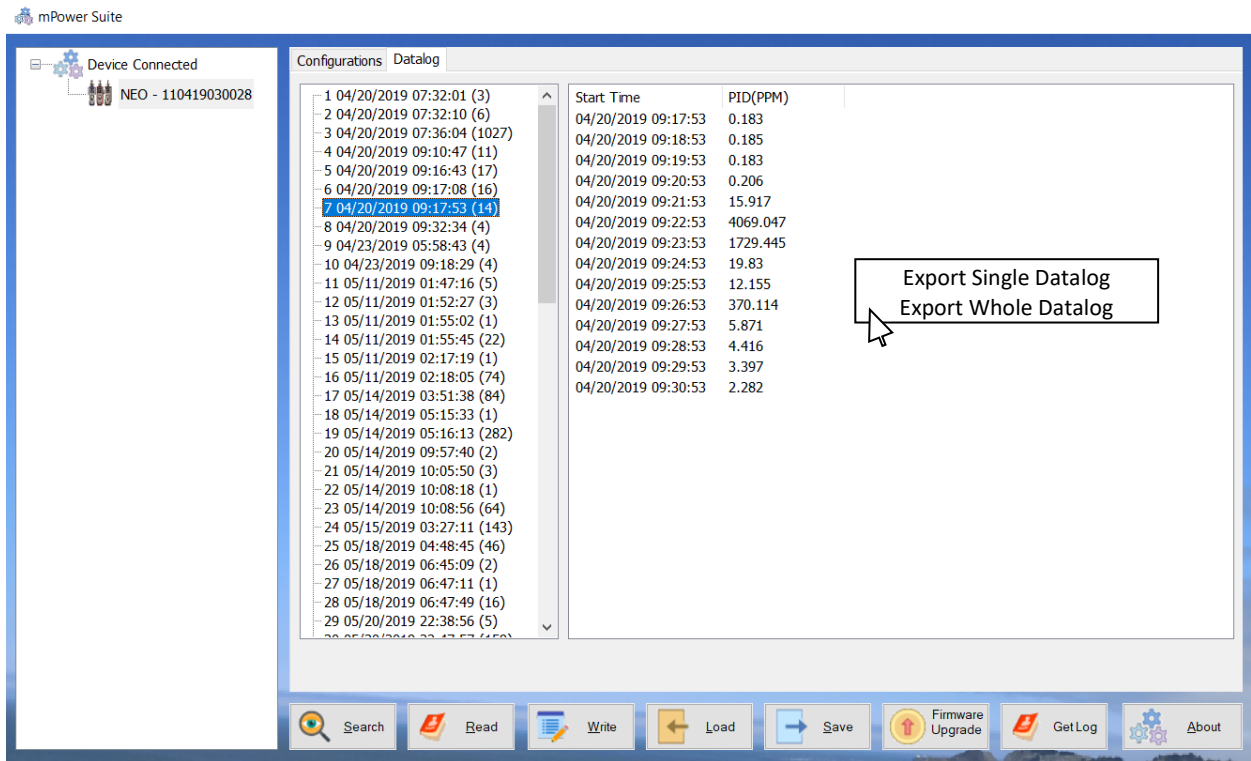

mPower Suite Datalog Screen

Maintenance

Cleaning or Changing PID Sensor/Lamp

Lamp Cleaning and Changing

1. Unscrew the Sensor Cap and pull the sensor straight out, using a slight rocking motion if necessary.
2. Put on finger gloves and pull out the lamp. Insert a new lamp, or clean the existing lamp as described below.
3. Use a cotton swab wetted with methanol to clean the flat window surface of the lamp. If greasy dirt is hard to remove using methanol, the window can be polished using fine alumina powder polishing paste.
4. Use a clean tissue to wipe the lamp window again.
5. Re-insert the cleaned lamp, plug in the sensor and screw on the sensor cap.
6. Always re-calibrate the PID after cleaning the lamp and/or sensor.



Sensor Cleaning

1. Unscrew the sensor cap.
2. Pull the sensor straight out, using a slight rocking motion if necessary.
3. Put the sensor into a beaker and cover it with pure methanol or ethanol.
4. Put the beaker into an ultrasonic cleaning bath and sonicate for 5 minutes. Then replace the alcohol with distilled water and sonicate for 2 minutes. Lastly, take out sensor and dry it. If possible, use a gentle stream of clean air to blow the residual liquid out of the sensor.
5. Always re-calibrate the PID after cleaning the sensor.



Sampling Pump

The flow rate should be roughly 250-350 cc/min at low pump speed and 350-450 cc/min at high pump speed when there is no air leakage. When approaching the end of its useful operating life, the pump will consume more energy and draw significantly lower flow. Also, if excessive dust or particles enter the pump, the flow will be reduced. A strong pump should stall and/or nearly stop when a finger is used to block the inlet. If the pump does not stall but the flow is weak, it is likely that particles are trapped in the pump diaphragm. When this occurs, it is necessary to replace or rebuild the pump, or clean the diaphragm. Repair of the pump requires removal of the circuit board and is preferably done by an authorized service center.

Troubleshooting

Problem	Possible Reasons	Solutions
Cannot turn on power after charging the battery	Defective battery.	Call authorized service center to replace battery
Reading abnormally High	Dirty Filter.	Replace filter.
	Dirty sensor module.	Clean or replace sensor module.
	Excessive moisture or water condensation.	Blow-dry the sensor module.
	Incorrect calibration.	Calibrate the unit.
Reading abnormally Low	Dirty filter.	Replace Filter.
	Dirty sensor module.	Clean or replace sensor module.
	Weak or dirty lamp.	Clean or replace lamp.
	Incorrect calibration.	Calibrate the unit.
Buzzer inoperative	Buzzer disabled	Check that buzzer is not turned off.
	Bad buzzer	Call authorized service center.
Inlet flow too low	Pump diaphragm damaged or has debris.	Call authorized service center.
	Flow path leaks.	Check flow path for leaks; e.g., sensor module O-ring, tube connectors, Teflon tube compression fitting.
“Lamp” alarm on during operation	Lamp drive circuit.	Turn unit off and back on.
	Weak or defective PID Lamp.	Replace UV Lamp
PC does not recognize instrument	Wrong cable	Use mPower USB cable P/N M-011-3003-000

Contact Information

mPower Electronics Inc.

3046 Scott Blvd. Santa Clara, CA 95054 USA

Phone: (408) 320-1266

Toll Free: (866) mPower7 (866) 676-9377

Fax: (669) 342-7077

info@mpowerinc.com

www.mpowerinc.com

